

VP7215/95DPC Powered 15" 2-Way Integrated Loudspeaker System

Professional Series

Key Features:

- ▶ Compact Powered bi-amplified full-range loudspeaker with JBL DrivePack® technology for portable or installed use
- ▶ Optimized for both portable/rental or permanent-venue use
- ▶ 1750 watts peak output power, 875 watts continuous
- ▶ 15-inch Differential Drive® low-frequency driver for extended low-frequency output
- ▶ Robust powder-coated die cast aluminum handles, designed for strength and comfort
- ▶ Integrated 35 mm stand mount

Applications:

- ▶ High-impact audio/visual presentations
- ▶ Theatrical stage sound design
- ▶ Houses of Worship
- ▶ Live performance venues
- ▶ Performing arts centers
- ▶ Corporate learning centers
- ▶ Themed entertainment venues
- ▶ Sound reinforcement rental companies

The VP7215/95DPC is a powered 15" 2-way integrated loudspeaker system featuring 1750 watts of peak output power, and onboard digital signal processing.

Designed in cooperation with Crown International, the JBL DrivePack® DPC-2 amplifier module features Crown's Class D digital power amplification circuitry.

DBT (Dual-Bridged Technology™) directly links discrete amplifier channel outputs to each voice-coil in the Differential Drive loudspeaker. Electrical power transfer to the transducer is optimized for maximum system performance.

VP7215/95DPC transducers are JBL's 2265FF 15" diameter Differential Drive woofer and the JBL 2452H-SL compression driver. The high frequency driver is coupled to a JBL PT-F95HF Progressive Transition™ (PT) Waveguide for excellent 90° x 50° pattern control, smooth frequency response, and low distortion.

The VP7215/95DPC is equipped with an integrated 35 mm stand mount.



Specifications:

Frequency Response (+/-3 dB):	60 Hz - 18 kHz
Frequency Range (-10 dB):	45 Hz - 20 kHz
Coverage Pattern:	90° x 50°
Directivity Factor (Q):	12.6
Directivity Index (DI):	11 dB
Maximum Peak Output†:	135 dB SPL 1m
Transducer Section:	
Low Frequency Section:	JBL 2265FF, 381 mm (15 in) dia., 76 mm (3 in) Dual Coil neodymium Differential Drive®, Direct Cooled
Bandpass Nominal Impedance:	2 x 2 ohms
High Frequency:	JBL 2452H-SL, 100 mm (4 in) titanium damped diaphragm, 1.5 in. exit.
Bandpass Nominal Impedance:	8 ohms
System:	
DPC1 Internal Amplification Output (at nominal load)	1750 Watts Peak, 875 Watts Continuous
DPC1 Output (Continuous IEC shaped pink noise into rated load impedance):	750LF/125HF Watts
DPC1 Output Section:	LF: Dual Bridged Technology™, Class D HF: Bridged Class D
Audio Input connector	XLR with loop-through
User Controls:	80 Hz Subwoofer High Pass Filter. Enable/Disable 0-16 dB input Attenuator with 32 precision 0.5 dB steps
Signal Processing:	DSP based, resident in Input Module.
System Management:	DSP based limiters for mechanical and thermal protection
AC Power Operating Range:	90-132 VAC/216-264 VAC, 50/60 Hz
AC Line Voltage:	50/60 Hz; User Selectable; 120V/240V (-15%, +10%)
AC Input Connector:	Neutrik PowerCon (NAC 3MPA)
AC Loop-thru:	Neutrik PowerCon (NAC 3MPB)
AC Current Requirement:	6A per system at 120V, 3A per system at 240V
Enclosure:	
Box Construction:	5/8 in. multi-ply exterior grade Baltic birch. Internally braced. Black DuraFlex™ finish.
Suspension System:	13 M10 Fittings, 35 mm pole mount socket
Grille:	14 Gauge Black powder-coated perforated steel with foam backing.
Dimensions (H x W x D):	613 x 434 x 359 mm 24.1 x 17.1 x 14.1 in
Net Weight:	24.7 kg (55 lb)

†Measured with IEC shaped noise in free field conditions.

JBL continually engages in research related to product improvement. Some materials, production methods and design refinements are introduced into existing products without notice as a routine expression of that philosophy. For this reason, any current JBL product may differ in some respect from its published description, but will always equal or exceed the original design specifications unless otherwise stated.

▶ VP7215/95DPC Powered 15" 2-Way Integrated Loudspeaker System

Frequency Response

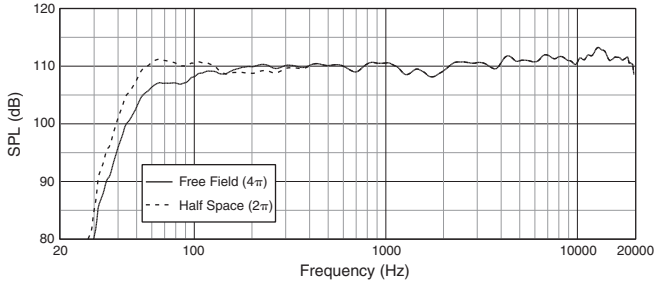

Horizontal Off-Axis Frequency Response

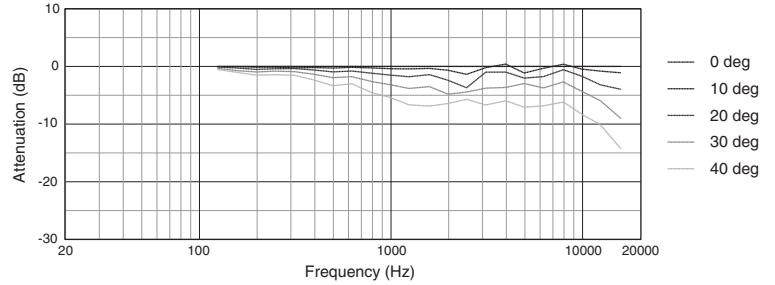

Beamwidth

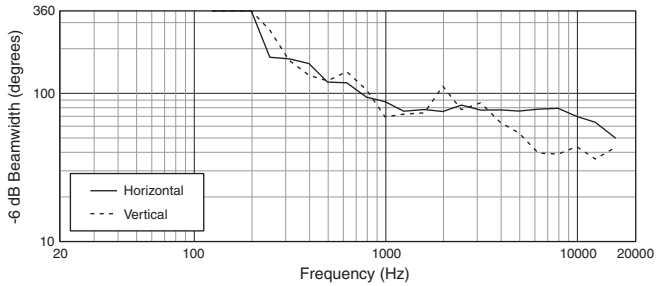

Vertical Off-Axis Frequency Response

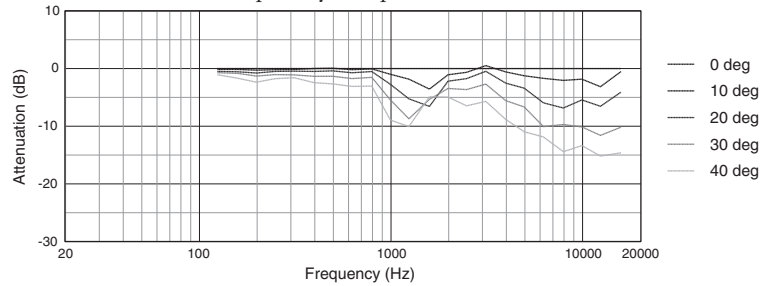

Directivity Index, Q

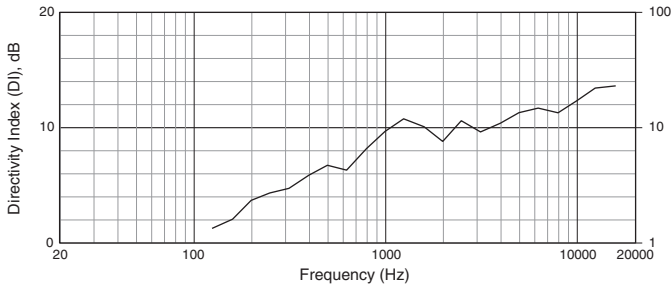

Vertical Down Off-Axis Frequency Response

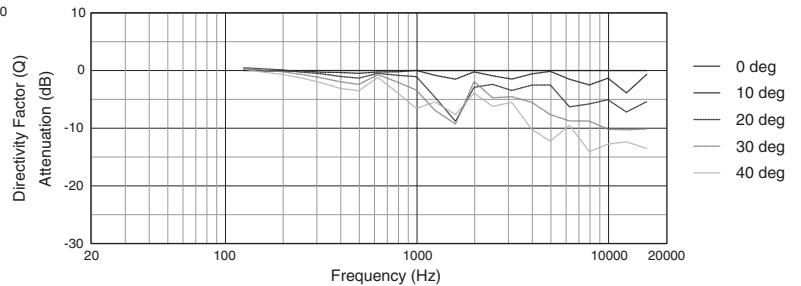

Dimensions

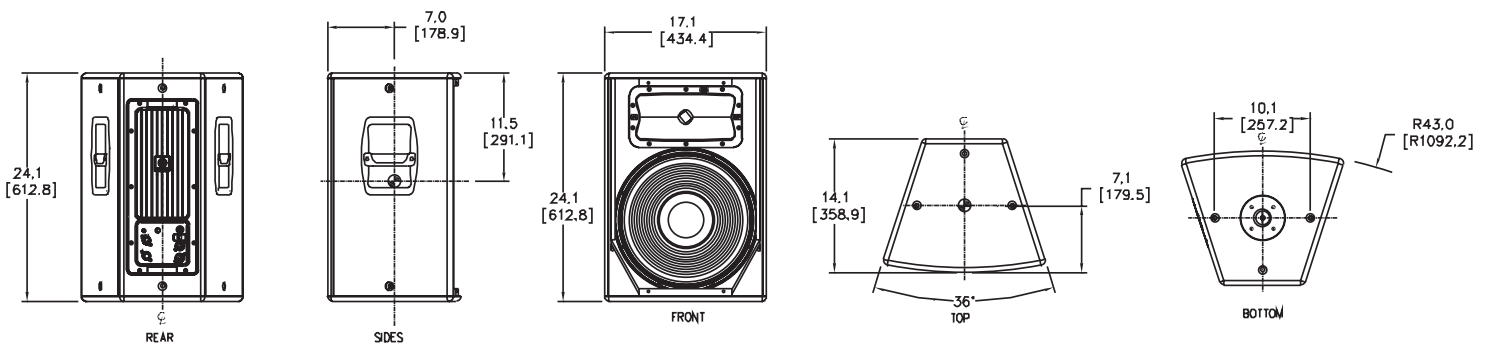

Dimensions in mm (in)

Accessories:

JBL offers a wide variety of accessories including rigging accessories and transport covers. Please visit www.jblpro.com for a complete list of VP Series accessories.



VP SERIES
venue performance



JBL Professional
8500 Balboa Boulevard, P.O. Box 2200
Northridge, California 91329 U.S.A.

■ A Harman International Company
© Copyright 2008 JBL Professional
www.jblpro.com

SS VP7215/95DPC
CRP 5M
09/08